

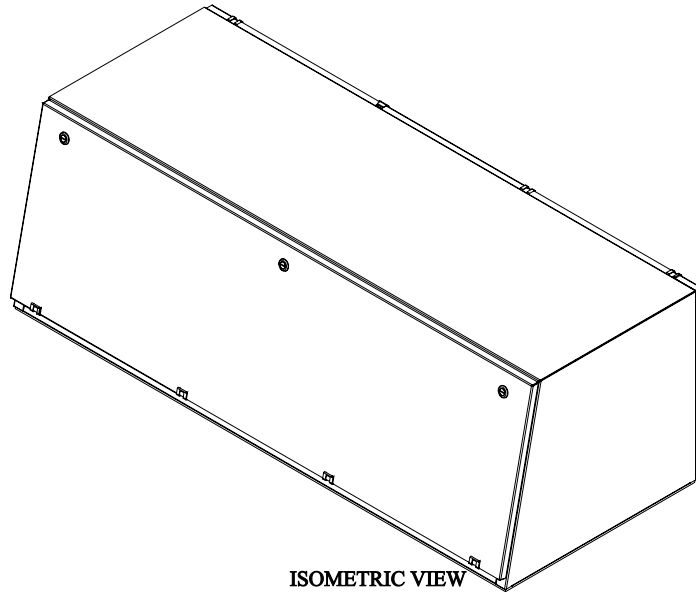

PART No. 2CST206043

for more information visit
www.hammfg.com
Data subject to change without notice
Isometric drawing Not to Scale



ISOMETRIC VIEW

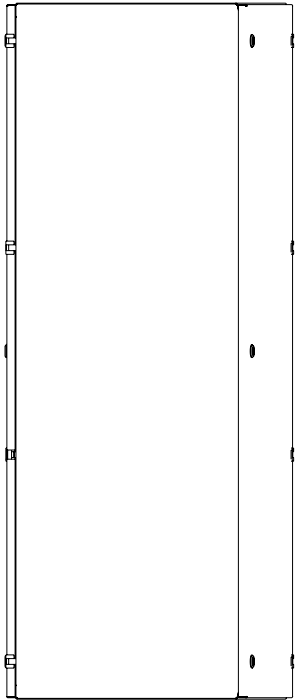

TOP VIEW

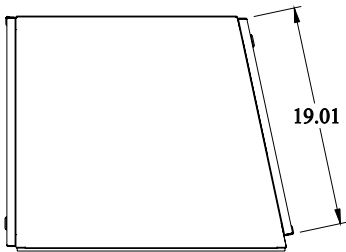

LEFT SIDE VIEW

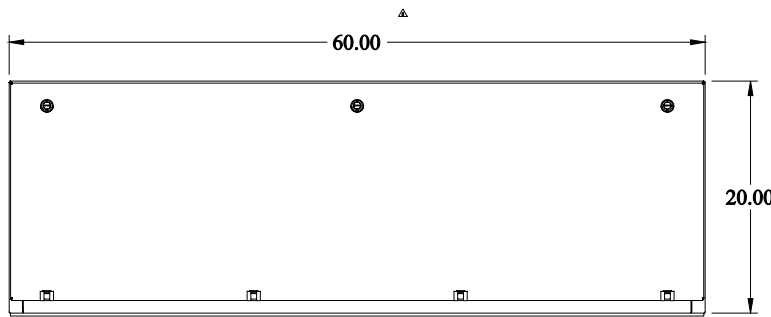

FRONT VIEW

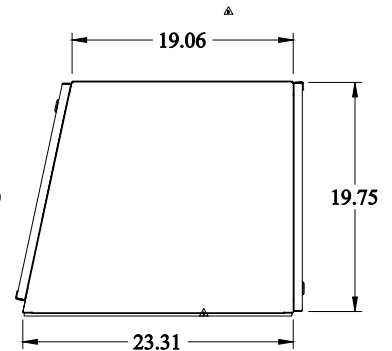

RIGHT SIDE VIEW